

# Sequoia Professional Glennville Lounge Chair

## Assembly Guide

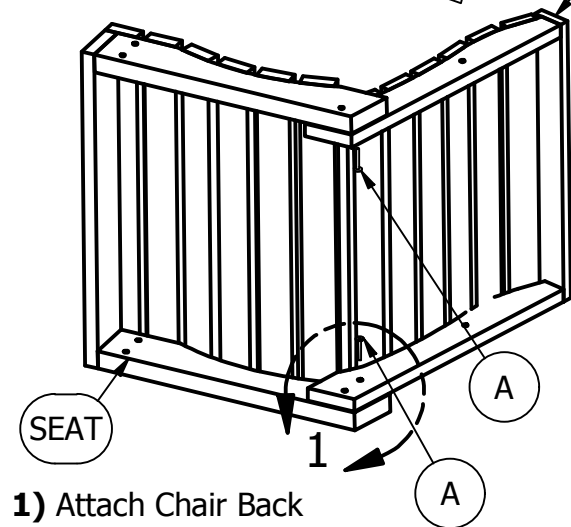
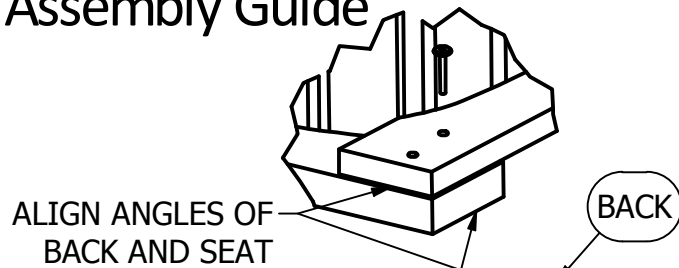

**1)** Attach Chair Back to Seat Using One "A" Bolt in the Upper Hole on Each Side.

**2)** Attach Leg Assembly to Seat Using Two "B" Bolts in Front and One "C" Bolt in Rear. Attach Arm to Back Using One "A" Bolt.

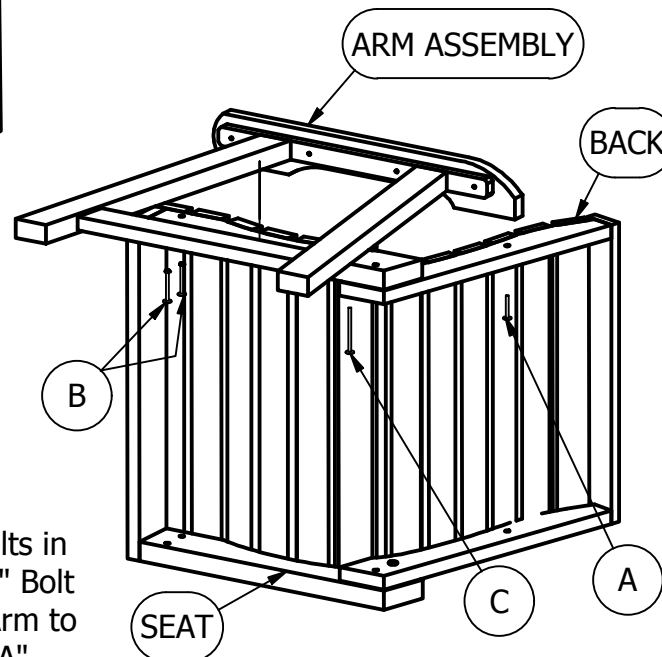

**3)** Repeat on Other Side.

### HARDWARE

A  x4  
1/4"-20 X 1.5"

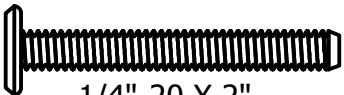
B  x4  
1/4"-20 X 2"

C  x2  
1/4"-20 X 3"

### IMPORTANT!

DO NOT fully tighten the bolts until all bolts are started. Once all bolts are inserted, go back & tighten all the bolts.

Retain these instructions for future reference

### INCLUDED TOOLS

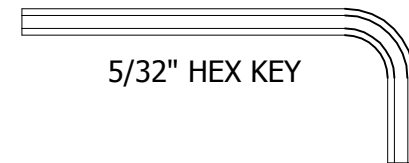

5/32" HEX KEY



SEQUOIA  
PROFESSIONAL  
by highwood®

For information on Care and Cleaning or to register your SEQUOIA PROFESSIONAL product by highwood®, please visit [www.highwood-usa.com](http://www.highwood-usa.com).

CM-CHGSQ02  
03.05.19

PAGE 1 OF 1